

Terabit™

Industrial 1.8" Micro SATA 6.0Gbp.s Solid State Drive

Data Sheet

Terabit Technology

Revision History

Version	Date	Changes	Note
V001	2015-06-28	Release	3 rd Gen SATAIII
	2016-02-16	512GB added	

Terabit Technology

Contents

1. Product Features.....4

2. Overview.....5

3. Interface.....5

4. Physical Dimension.....6

5. PIN Description.....7

 5.1 PIN Location.....7

 5.2 Signal Description.....7

6. Power Consumption.....8

7. Product Reliability.....8

 7.1. Wear Leveling.....9

 7.2 ECC.....9

 7.3 MTBF.....9

 7.4 Bad-block Management.....9

 7.5 S.M.A.R.T Function.....9

 7.6 TRIM Function.....9

 7.7 Secure Erase.....10

8. Performance.....11

9. Cache.....11

10. Thermal Sensor.....11

11. Certifications.....12

12. Ordering Information.....13

13. Contact Information.....13

1. Product Features

Interface	7PIN+9PIN Male
Form Factor	1.8" Micro SATA 6.0GBps
Dimension	78.5 x 54.0 x 5.0 ±0.15(mm)
Capacity	NAND MLC: 32GB~512GB NAND SLC: 16GB~256GB
Performance	Read up to 500MB/s Write up to 460MB/s
Power Supply	D/C 3.3V
Operating Temperature	Standard: 0~+70°C Industrial: -20~+70°C Extended: -40~+85°C
Weight	<42g
Storage Temperature	-55~+95°C
Shock	Non-operating 1500G peak, 0.5ms Operating 50G peak, 11ms
Vibration	Jet (Random) Vibration, 10-2000Hz, 16.4G(X, Y, Z)
Burn-in Test	72 Hours
Falling Test	1.1 meter free falling
Max. Power Consumption	Sequential Reading 2.70W Sequential Writing 3.90W Idle 0.33W
MTBF	2,000,000 Hours
Features	<ul style="list-style-type: none"> - Enhanced endurance by dynamic/static wear-leveling - Support dynamic power management - Support S.M.A.R.T function - Automatic Bad-block Management - Support NCQ Command - Support BCH ECC 66bits/1024bytes - Support Self-healing technology, automatically detect and correct hidden error bit - Write Protect Function optional - Secure Erase by software optional - Support GPIO
Data Retention	@25°C : 10 years
Certification	CE/FCC/RoHS

2. Overview

Terabit 1.8" Micro SATA SSD fully consists of semiconductor devices using Toshiba original NAND Flash and Industrial Controller which provide high reliability and high performance for data storage. Terabit 1.8" Micro SATA SSD has standard 7PIN+9PIN interfaces, fully conform to the same mechanical and mounting requirements as standard rotating disk drives. This series of products are designed for premium industrial applications that require both strong reliability and high performance such as Industrial Computer, Rugged Computer, Industrial Systems, Industrial Server, Embedded Systems, Workstations, RAID and Defense. With up to 512GB on NAND MLC Flash and 512GB on NAND SLC, Terabit 1.8" Micro SATA SSD totally goes through a variety of proofing tests such as Shock Test, Vibration Test, Burn-in Test, and Twisting Test. Well proved under -40~+85°C wide temperature and equipped with Power Failure Protect and Over Load Protect, this series of products can work smoothly under severe environments.

3. Interface

Terabit 1.8" Micro SATA Solid State Drive complies SATAIII Standard.

Compliant to SATAII standard

Standard Serial ATA 2.6

ATA-compatible Command Set

4. Physical Dimension

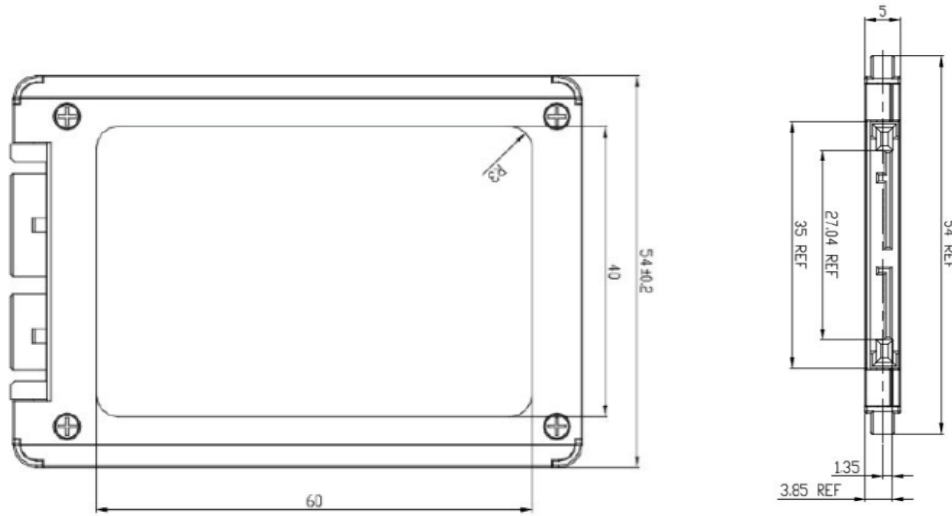

Parameter	Value	Unit
Length	78.5	mm
Width	54.0	mm
Height	5.0	mm

- All of the values are $\pm 0.15\text{mm}$

5. PIN Description

5.1 PIN Location

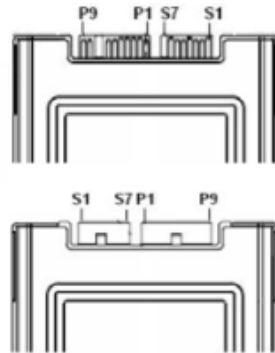

5.2 Signal Description

PIN#	PIN Name	PIN Definition
Signal		
S1	GND	2 nd mate
S2	RX+	Differential signal pair A From physical layer electronics
S3	RX-	
S4	GND	2 nd mate
S5	TX-	Differential signal pair B From physical layer electronics
S6	TX+	
S7	GND	2 nd mate
Power		
P1	V33	3.3V power
P2	V33	3.3V power
P3	GND	
P4	GND	
P5	V5	Not used
P6	V5	Not used
P7	GND	Not used
P8	Optional	Not used
P9	Optional	Not used

6. Power Consumption

Capacity	Idle	Read	Write	Unit
16GB	0.27	1.95	3.42	W
32GB	0.27	2.00	3.52	W
64GB	0.27	2.15	3.60	W
128GB	0.28	2.20	3.75	W
256GB	0.30	2.55	3.82	W
512GB	0.33	2.70	3.90	W

7. Product Reliability

NAND MLC Flash:

Capacity	Endurance Total Bytes Written	Data Retention	MTBF	Warranty
32GB	Up to 65TB	@25°C >10 Years	2 Million Hours	3 Years Limited
64GB	Up to 130TB			
128GB	Up to 260TB			
256GB	Up to 520TB			
512GB	Up to 1040TB			

NAND SLC Flash:

Capacity	Endurance Total Bytes Written	Data Retention	MTBF	Warranty
16GB	Up to 900TB	@25°C >10 Years	2 Million Hours	5 Years Limited
32GB	Up to 1800TB			
64GB	Up to 3600TB			
128GB	Up to 7200TB			
256GB	Up to 14400TB			
512GB	Up to 28800TB			

*Total Bytes Written= 【 (Flash P/E cycle) x (number of bits in drive) 】 /WAI
WAI=1.428704724

7.1 Wear-Leveling

Terabit 1.8" Micro SATA SSD support both static and dynamic wear-leveling technology. These two algorithms guarantee each block of flash memory at same level of erase cycles to improve lifetime limitation of NAND based storage.

7.2 ECC

ECC (Error Correction Code): Enhanced configurable BCH ECC engine. Terabit 1.8" Micro SATA SSD implements the BCH ECC Algorithm, which is one of the most powerful ECC algorithms in the industry. This algorithm can correct up to 12 random bit errors in each 512 bytes.

7.3 MTBF

Mean time between failures (MTBFs) for the SSD can be predicted based on the component reliability data using the methods referenced in the Telcordia SR-332 reliability prediction procedures for electronic equipment, the prediction result for this SSD is more than 2,000,000 hours.

7.4 Bad-block Management

Terabit implements an efficient bad block management algorithm into the SSD to detect factory produced bad blocks as well as those that develop over the lifetime of the device. This process is completely transparent to the user through the use of S.M.A.R.T. command tools, i.e., the user will not be aware of the existence of the bad blocks during operation.

7.5 S.M.A.R.T Function

S.M.A.R.T stands for Self-Monitoring, Analysis and Reporting Technology. This technology enables the PC to predict the future failure of hard disk drives. Through the S.M.A.R.T. system, Terabit 1.8" Micro SATA SSD incorporates a suite of advanced diagnostics that monitor the internal operation of the drive and provide an early warning for many types of potential problems. When a potential problem is detected, the SSD can be repaired or replaced before any data is lost or damaged.

7.6 TRIM Function

Terabit Solid State Drive equips built-in TRIM function, it locates and marks the useless data, and help GC function to collect and clean, which keeps the system in a high performance status even after long-term using.

7.7 Secure Erase

Terabit 1.8" Micro SATA SSD supports secure erase function by software, which can erase all data in fast speed and the erased data could not be recovered. Terabit offers several erase commands to meet military standards. These ATA commands have been designed to remove data under certain pattern and with specified activities, and they shall be triggered by sending ATA Commands via software.

Terabit supports ATA Standards including below:

- 1) AFFSI 5020
- 2) DoD 5220.22-M
- 3) USA Navy NAVSO P-5239-26
- 4) NSA Manual 130-2
- 5) USA-Army 380-19
- 6) NISPOMSUP Chap 8, Sect. 8-501
- 7) NSA/CSS 9-12
- 8) AFFSI 8580

* For each product only one standard could be selected and no modifications will be supported.

8. Performance

Capacity	Sequential Read	Sequential Write	IOPS Read	IOPS Write
16GB	102MB/s	81MB/s	2200	2000
32GB	277MB/s	140MB/s	2600	2400
64GB	319MB/s	246MB/s	3000	2700
128GB	402MB/s	320MB/s	3200	3000
256GB	481MB/s	392MB/s	3500	3200
512GB	500MB/s	460MB/s	4000	3500

9. Cache

Cache	DDR2	DDR3	Capacity
Support	/	Yes	N/A

10. Thermal Sensor

Thermal monitors are devices for measuring temperature, and can be found in SSDs in order to issue warnings when SSDs go beyond a certain temperature. The higher temperature the thermal monitor detects, the more power the SSD consumes, causing the SSD to get aging quickly. Hence, the processing speed of a SSD should be under control to prevent temperature from exceeding a certain range. Meanwhile, the SSD can achieve power savings.

11. Certifications



EN 55022:2010

EN: 55024:2010

EN 61000-3-2:2013

EN 61000-3-3:2014

47 CFR, Part2, Part15, CISPR PUB.22

With reference to RoHS Directive 2011/65/EU recasting 2002/95/EC

Terabit Technology

12. Ordering information

Series	*Model Name	Capacity	Flash
1.8" Micro SATA SSD	T(E)18MSS3XTMLC-032G	32GB	NAND MLC
	T(E)18MSS3XTMLC-064G	64GB	NAND MLC
	T(E)18MSS3XTMLC-128G	128GB	NAND MLC
	T(E)18MSS3XTMLC-256G	256GB	NAND MLC
	T(E)18MSS3XTMLC-512G	512GB	NAND MLC

Series	Model Name	Capacity	Flash
1.8" Micro SATA SSD	T(E)18MSS3XTSLC-016G	16GB	NAND SLC
	T(E)18MSS3XTSLC-032G	32GB	NAND SLC
	T(E)18MSS3XTSLC-064G	64GB	NAND SLC
	T(E)18MSS3XTSLC-128G	128GB	NAND SLC
	T(E)18MSS3XTSLC-256G	256GB	NAND SLC
	T(E)18MSS3XTSLC-512G	512GB	NAND SLC

*XT refers to temperature range, ST refers to standard temperature, CT refers to industrial temperature, KT refers to extended temperature.

13. Contact Information

Shanghai Terabit Technology Co., Ltd

Telephone: +86.21.34303488

Fax: +86.21.34303488

Email: sales@terabitssd.com

Website: www.terabitsys.com

Address: #513, No.38 Building, Wanke VMO, No. 2049 Pujin Road, Pujiang Town, Minhang District, Shanghai, 201112, P.R. China